

Amantii

ELECTRIC FIREPLACES

INSTALLATION /OWNER'S MANUAL

CUBE-2025WM



SAFETY INFORMATION

WARNING

If the information in these instructions are not followed exactly, a fire or explosion may result causing property damage, personal injury or loss of life.

Do not store or use gasoline or other flammable vapors and liquids in the vicinity of this or any other

INSTALLER: LEAVE THIS MANUAL WITH THE APPLIANCE.

CONSUMER: RETAIN THIS MANUAL FOR FUTURE REFERENCE.



WARNING: This product can expose you to chemicals including Lead in the wiring, which is [are] known to the State of California to cause birth defects or other reproductive harm. For more information visit: www.p65warnings.ca.gov

TABLE OF CONTENTS

Please read and carefully follow all of the instruction found in this manual. The instructions included here will assure that you have many years of dependable and enjoyable service from your Amantii product.

Contents

IMPORTANT INSTRUCTIONS.....	3
FCC CAUTIONS	4
UNPACKING AND TESTING THE APPLIANCE	5
GROUNDING THE APPLIANCE.....	5
LOCATING THE FIREPLACE.....	5
CUBE-2025WM.....	6
INSTALLATION WALL-MOUNT	7
INSTALLATION CUBE-BASE-LEGS	8
INSTALLATION CUBE-BASE-SPEAKER.....	9
OUTDOOR INSTALLATION.....	10
HARDWIRE INSTALLATION	11
MEDIA OPTIONS.....	12
DECORATIVE MEDIA INSTALLATION.....	12
OPERATION.....	13
MANUAL OPERATION	13
REMOTE CONTROL OPERATION.....	14
WIFI OPERATION.....	17
REPLACEMENT PARTS	20
EXPLODED VIEW	21
WIRING DIAGRAM.....	22
TROUBLE SHOOTING.....	23
SERVICE HISTORY.....	24
WARRANTY	25

IMPORTANT INSTRUCTIONS

PLEASE RETAIN THIS USER GUIDE FOR FUTURE REFERENCE

When using electrical appliances, basic precautions should always be followed to reduce the risk of fire, electric shock, and injury to persons, including the following:

- 1) Read all instructions before using this fireplace
- 2) The fireplace is hot when in use. To avoid burns, do not let bare skin touch hot surfaces. Keep combustible material such as furniture, cushions, bedding, paper, clothes, curtains at least 3 feet from the front of the unit
- 3) Extreme caution is necessary when any heater is used near children and whenever the unit is left operating and unattended.
- 4) Do not operate a fireplace with a damaged cord or plug, or if the heater has malfunctioned, the fireplace has drooped or damaged in any manner
- 5) Not all fireplaces are suitable for use in bathrooms or laundry facilities. Please consult with individual product literature to confirm suitability
- 6) Do not run the cord under carpeting. Do not cover cord with throw rugs, runners or the like. Arrange the cord away from traffic area and where it will not be tripped over
- 7) Do not modify this fireplace. Use it as described in the manual. Any other use not recommended by the manufacture may cause fire, shock or injury to persons
- 8) Do not use this heater with programmer, timer, separate remote-control system or any other device that switches the heater on automatically, since a fire risk exists if the heater is covered or positioned incorrectly
- 9) Disconnect all power supply before cleaning, maintenance or relocation of the fireplace
- 10) Keep the heater clean. Do not allow any objects to enter any ventilation or exhaust opening as this may cause electric shock, fire or damage to the heater
- 11) Do not immerse the cord, plug or any part of the appliance in water or any other liquid
- 12) In order to avoid a hazard due to inadvertent resetting of the thermal cut-out, this appliance must not be supplied through an external switching device

CAUTION: Procedures and techniques, which, if not carefully followed, will result in damage to the equipment.

WARNING: Procedures and techniques, which, if not carefully followed, will expose the user to the risk of fire, serious injury, illness or death.

Consult with professional electrician and adhere to all code requirements for installations in bathrooms

FCC CAUTIONS

This device complies with part 15 of the FCC Rules. Operation is subject to the following two conditions: (1) This device may not cause harmful interference, and (2) this device must accept any interference received, including interference that may cause undesired operation.

Any Changes or modifications not expressly approved by the party responsible for compliance could void the user's authority to operate the equipment.

Note: This equipment has been tested and found to comply with the limits for a Class B digital device, pursuant to part 15 of the FCC Rules. These limits are designed to provide reasonable protection against harmful interference in a residential installation. This equipment generates uses and can radiate radio frequency energy and, if not installed and used in accordance with the instructions, may cause harmful interference to radio communications. However, there is no guarantee that interference will not occur in a particular installation. If this equipment does cause harmful interference to radio or television reception, which can be determined by turning the equipment off and on, the user is encouraged to try to correct the interference by one or more of the following measures:

Reorient or relocate the receiving antenna.

Increase the separation between the equipment and receiver.

Connect the equipment into an outlet on a circuit different from that to which the receiver is connected.

Consult the dealer or an experienced radio/TV technician for help.

This equipment complies with FCC radiation exposure limits set forth for an uncontrolled environment. This equipment should be installed and operated with minimum distance 20cm between the radiator & your body.

UNPACKING AND TESTING APPLIANCE

Carefully remove the appliance from the box.

Prior to installing the appliance, test to make sure the appliance operates properly by plugging the power supply cord into a conveniently located 120 Volt grounded outlet.

Test all aspects of its operation (manual switches, remote and heater) to make sure all components operate correctly.

As with most electronic devices, your new electric fireplace has been designed to operate at temperatures between 5°C (41°F) and 35°C (95°F). During the cold winter months, allow the fireplace to reach room temperature before turning it on.

NOTE: There may be trace of odor during the first few minutes of initial use. This is harmless, normal and will never occur again.

GROUNDING APPLIANCE

This appliance is for use on 120 Volts. The cord has a plug as shown in (A). An adapter as shown in (C) is available for connecting three-blade grounding type plugs to two-slot receptacles. The green grounding lug extending from the adapter must be connected to a permanent ground such as a properly grounded outlet box. The adapter should not be used if a three-slot grounded receptacle is available.

To disconnect appliance, turn controls to off, then remove plug from outlet.

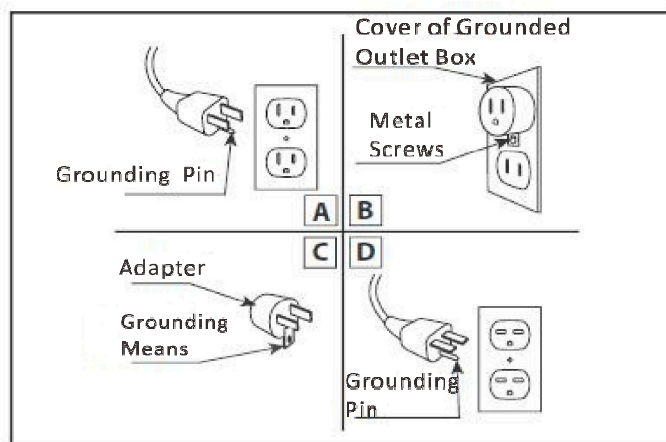

LOCATING THE FIREPLACE

Plan where to locate and frame the fireplace. This will save time and money later when you install the fireplace. Before installation consider the following:

1. Where the fireplace is located must allow for wall and ceiling clearances.
2. Consider a location where the fireplace screen will not be exposed to direct sunlight from windows or doors.
3. A 15 ampere, 120 Volt, 60 Hz branch circuit with proper ground must be available at the location. Preferably a dedicated branch circuit should be provided to avoid circuit breakers to trip or fuses to blow.

CUBE-2025WM

Description	ELECTRIC FIREPLACE
Voltage	120V AC 60Hz
Watts	1500W Max
NO HEATER	25W
MOTOR HEATER	19W
Appliance Width	19 5/8" or 50 cm
Appliance Height	25 1/4" or 64.1 cm
Appliance Depth	11 3/4" or 30 cm
Gross Weight	50.7 lbs or 22 kgs
Plug Location	Left side
Cord Length	70 7/8" or 180 cm
BTU	4800

This appliance has been tested in accordance with the UL Standard 2021 for fixed and location dedicated electric room appliances in the United States and Canada. If you need assistance during installation, please contact your local dealer.

NOTE: This appliance must be electrically wired and grounded in accordance with local codes. In the absence of local codes, use the current CSA C22.1 Canadian Electrical Code in Canada or the ANSI/NFPA 70 National Electrical Code in the United States.

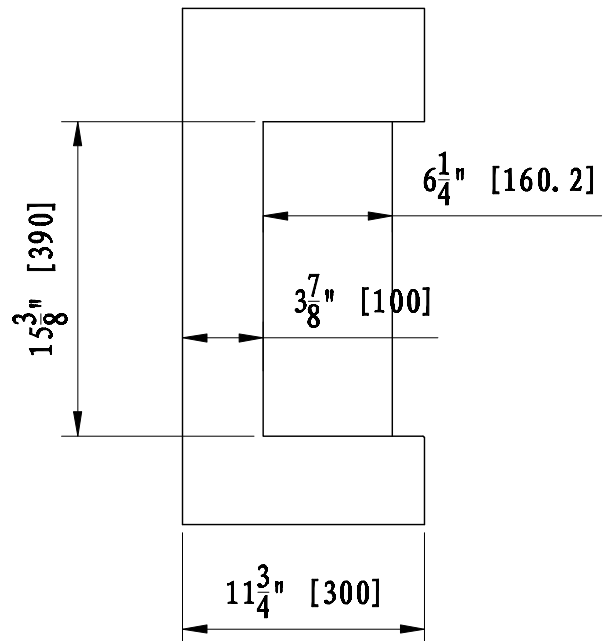
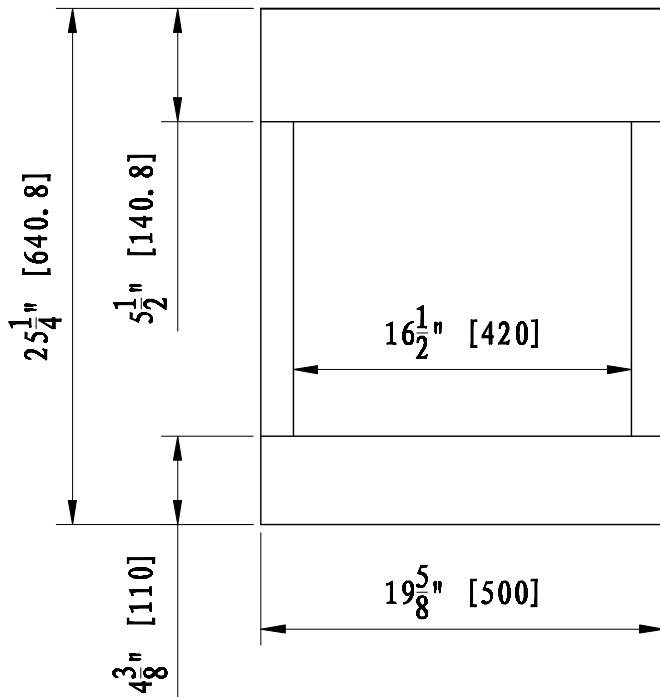

INSTALLATION WALL-MOUNT

NOTE: Due to the many different materials used on different walls, it is highly recommended that you consult your local builder before you install this appliance.

1. Select a location that is not prone to moisture and is located at least 0.91 m or 3 feet away from combustible materials such as curtains or drapes, furniture, bedding, paper, etc.
2. Select a suitable position in which to mount the heater horizontally – use a spirit level to achieve this (Fig. 1).
3. Check the wall to ensure there is no wiring, pipe wires etc. in the area to be drilled. Drill 8 or more pilot holes (8mm diameter & 40mm depth) using a suitable size drill and put the wall plugs into the holes.
4. Take out the hanger from the fireplace by unscrew the screw (Fig.2).
5. Fix the hanger to the wall. Referring to Fig. 3.
6. Avoid fireplace to move, use screw fix fireplace to wall (Fig. 4).

Warning!

Be sure that the bolts have been fixed firmly enough to withstand the weight !

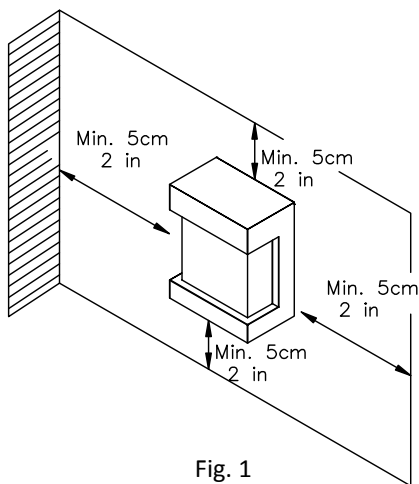

Fig. 1

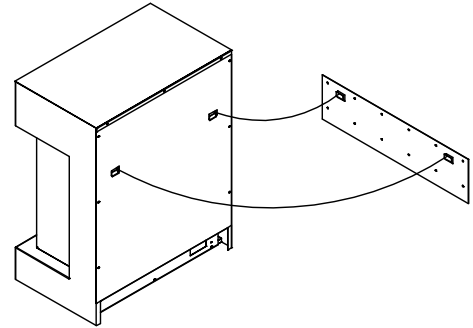

Fig. 2

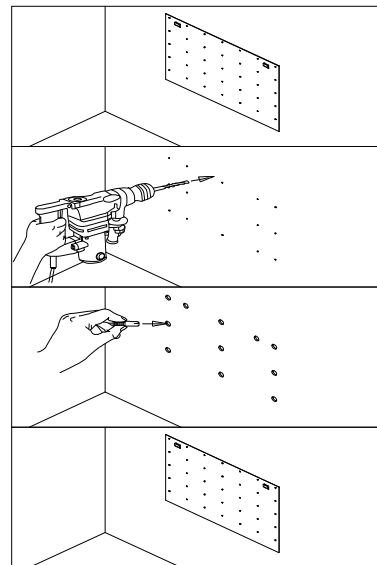

Fig.3

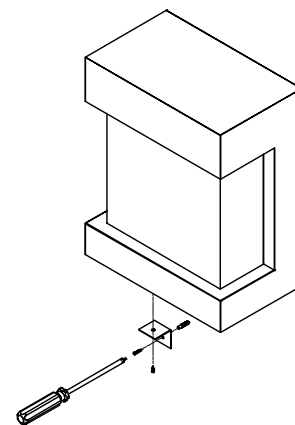
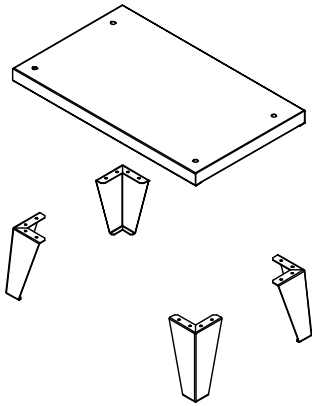

Fig. 4

INSTALLATION CUBE-BASE-LEGS

1. Screw the base legs to the steel panel.



3. Place the unit onto the base leg and screw in the adjustable feet, fixing the unit and the base leg.

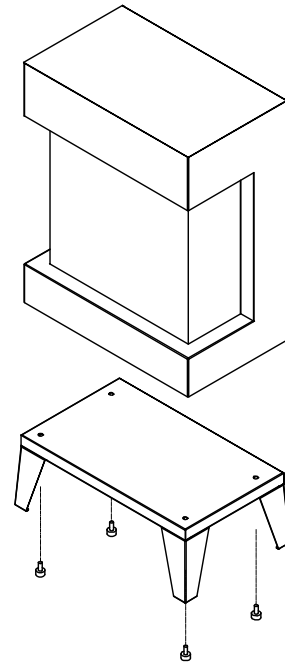

2. Unscrew the adjustable feet from the bottom of the unit.

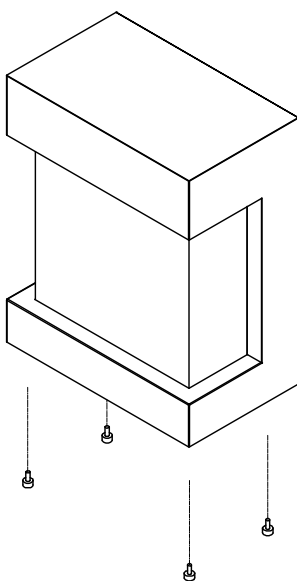

4. You have completed the installation of the CUBE-BASE-LEGS.

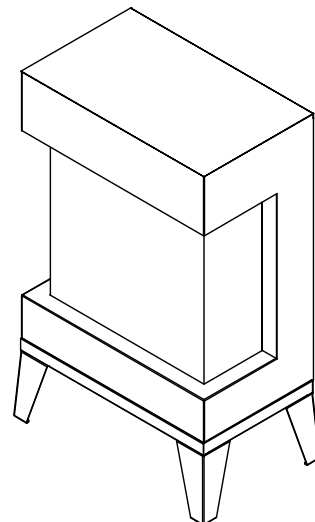

INSTALLATION CUBE-BASE-SPEAKER

1. Unscrew the adjustable feet from the unit.

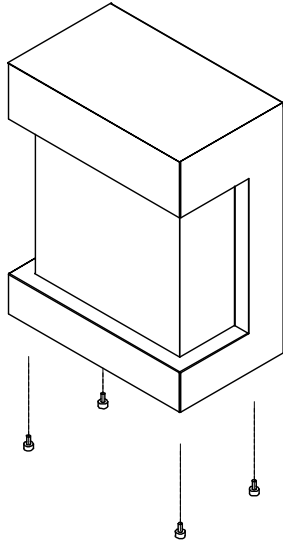

3. Place the unit on the CUBE-BASE-SPEAKER and screw in the adjustable feet, fixing the unit and the speaker box.

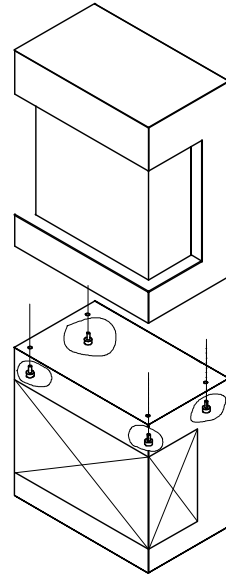

2. Unscrew the rear screws and remove the back steel panel

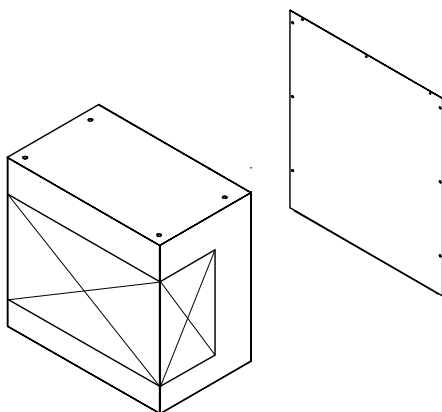

4. Plug into the back of the unit. Re-install the back steel panel.

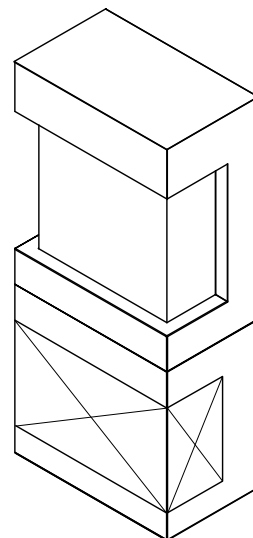

INSTALLATION OUTDOOR

The Cube (Cube 2025WM) is suitable for installation in outdoor areas protected from direct water impingement. In addition to maintaining the listed mantel and combustibles clearances, a rain protection overhang factor of 1/2 shall be constructed to the front and to each side of the installed appliance. See illustration below. All wiring connections to line power shall be in accordance with local building code requirements.

NOTE: The CUBE Wall Mount Unit is approved for outdoor use. The Cube Speaker Base and Cube Leg Base are NOT approved for use outdoors.

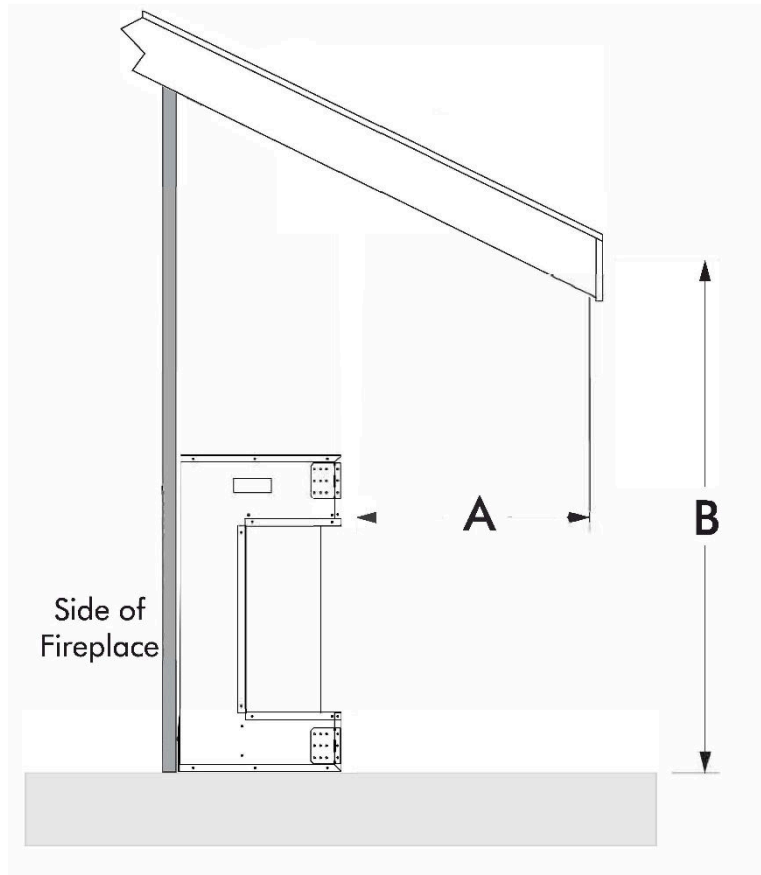

The overhang (A) must extend at least 1/2 the roof-line height (B). Height is measured from the base of the fireplace.

For example: if the roof-line (B) is 8' above the base of the fireplace, the overhang (A) must be at least 4'.

HARDWIRE INSTALLATION

Turn off the appliance completely and let cool before servicing. Only a qualified technician should service and repair this electric appliance.

If it is necessary to hard wire this appliance, a qualified electrician must remove the cord connection, and wire the appliance directly to the house hold wiring.

This appliance must be electrically connected and grounded in accordance with local codes, if hard wired. In the absence of local codes, use the current CSA C22.1 CANADIAN ELECTRICAL CODE in Canada or the current ANSI/NFPA 70 NATIONAL ELECTRICAL CODE in the United States.

1. Remove the cover plate from the left side of the appliance by removing the two screws, as shown below. Unscrew and remove power cord.



2. Attach the wiring to the junction block. Please make sure the live wire goes into the "L", the neutral wire into "N" and the ground wire into "G".



3. Replace the steel plate and screws.

MEDIA OPTIONS

The media that come with this appliance are Birch Log Set, "Clear glass", Amber glass, one (1) bag of Black Vermiculite and one (1) bag of White Vermiculite. Consumers may purchase optional decorative media if they choose. See dealer for more details.



Birch log set



Clear glass Amber glass Vermiculite

MEDIA INSTALLATION

STEP 1: Unplug the unit and make sure controls are switched off.

STEP 2: Unscrew 2 adjustable screws that securing the front glass panel. (Always secure the front glass before unscrewing the securing screws, removal of the securing screws may cause the front glass to fall out suddenly)

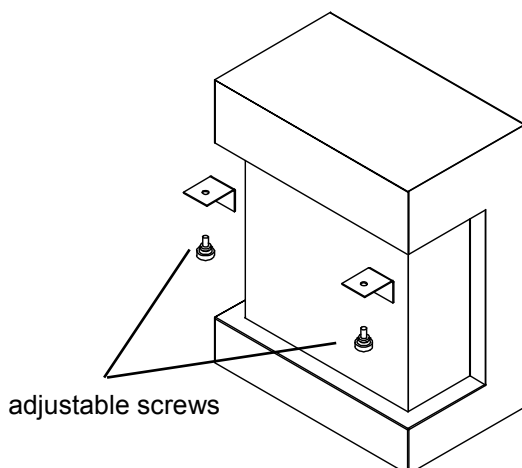

STEP 3: Remove the front glass panel to decorate your fireplace. Pour the decorative media into the tray. Feel free to use any combination of fire glass media that you find most appealing.

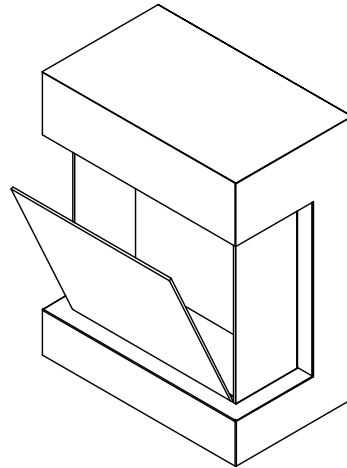

STEP 4: After finishing decoration, re-install the front glass panel using the securing screws removed in step 2.

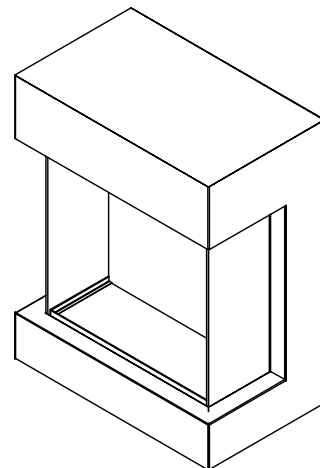







OPERATION

The Fireplace operates by using either the touch panel located on the upper left hand corner or by remote control.

Plug the fireplace into a 15 Amp wall socket.

MANUAL OPERATION













1. Press  to turn on and off the fireplace.
2. Press  to adjust the flame's brightness. There are 7 brightness levels (L5 – L4 - L3 – L2 – L1 – L0 – L6). The indicator light turns off automatically leaving it not operated within 10 seconds.
3. Press  to adjust the ember bed brightness. There are 12 brightness levels (D4 – D5 – D6 – D7 – D8 – D9 – DA – DB – D0 – D1 – D2 – D3).
4. Press  to set the turn-off time, 30min-1h-2h-3h-4h-5h-6h-7h-8h-t0. The indicator light turns off automatically leaving it not operated within 10 seconds. The timing turns off when  is pressed.
5. Press  to turn on and off the heater in its AUTO mode. The setting temperature switch through 59°F - 61°F - 63°F - 64°F - 66°F - 68°F - 70°F - 72°F - 73°F - 75°F - 77°F - 79°F - 81°F - 83°F - °F in Fahrenheit or 15°C -16°C -17°C - 18°C - 19°C - 20°C - 21°C - 22°C - 23°C - 24°C - 25°C - 26°C - 27°C - 28°C - °C in Celsius. The temperature setting mode will be closed automatically if leaving not operated for 5 seconds.
6. When the heater is on, press the  for 5 seconds to switch between Celsius and Fahrenheit.

REMOTE CONTROL OPERATION

For remote to function make sure the fireplace is plugged in and the remote has batteries.

Important: When operating the remote make sure you point the remote to the center of the fireplace. Each time you press the button, the buzzer inside the unit will beep once. It takes some time for the receiver to respond to the transmitter. Do not PRESS the buttons more than once within two seconds for correct operation.

Set the current time of the remote control

Press the  to activate the remote control and press to set  the time and date. When one of the “Sun” “Mon” “Tue” “Wed” “Thu” “Fri” “Sat” is flashing, press  or  to set the day of the week, press  to confirm day of the week and then enter hour setting. Press  or  to set the hour, press  to confirm the hour and then enter minute setting. Press  or  to set the minute and press  to confirm the minute and finish time setting.

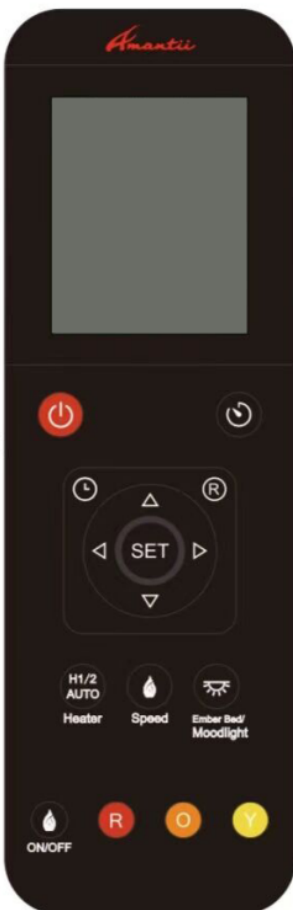





Press this Power button to turn on and off the fireplace.



Press this Timer button to set the time to turn off the fireplace. The available settings range from 30 minutes to 8 hours. As shown in the following: 0:30 - 1:00 - 1:30 - 2:00 - 2:30 - 3:00 - 3:30 - 4:00 - 4:30 - 5:00 - 5:30 - 6:00 - 6:30 - 7:00 - 7:30 - 8:00. Once you have set the timer, the  icon will be displayed on the LCD screen of the remote control. Press this button again to cancel the timer setting and the icon disappears.





Press the HEATER button once, one setting of heater works, 750W, indicating “H 1” on display; Press again, two settings of heater work, 1500W, indicating “H 2” on display; Press for the

third time to turn on the AUTO mode, press  or  to set the temperature and  or  to switch temperature unit between Celsius and Fahrenheit.





Press this button to adjust the speed of the flame. There are 3 options: High-Medium- Low.













Press this button to turn on and off the ember bed light. When in ON position, the display screen of the remote control shows AD 1, when the number “1” flashes, you can set the color of the ember bed by  or . There are 10 different ember bed light colors (AD1-10). When in AD 11 status, the color of the ember bed light cycles through 10 colors. Press “SET” to confirm the setting.







Press the Flame button to turn on and off the Flame. When in ON position, the LCD screen of the remote control shows 6 6 6. Press  or  or  to change the brightness of each color flame.







7 Day Timer Function

Press  once, 7 days from Monday to Sunday will display on the LCD screen of the remote control, press  within 5 seconds to enter 7 day timer function. When “Sun” flashes, press  or  to select the day that you want to set, press  to confirm your setting. Then “ON” will be display on the LCD screen of the remote control, at the same time, digital of time hour flashes, press  or  to set the time to turn the fireplace on. After setting the startup time, “OFF” will be displayed on the LCD screen and press  or  to set the shutdown time. When the shutdown time’s set, “AUTO” will be displayed on the LCD screen of the remote control and the digital of temperature flashes. At this time, you can set the temperature by  or . Now, you have finished setting of this function.

When the 7 day timer's set, the icon  will be displayed on the LCD screen of the remote control. Press  again to cancel the 7 day timer and the icon  will disappears.

NOTE: If the 7 day timing  and the general timing  are set at the same time, the system will respond to an earlier shutdown time.

 Press Refer button to check the settings of 7 day timer. Press  or  to see the settings of the day of the week and  or  the settings of the startup and shutdown time.

WIFI OPERATION

INSTALL TuyaSmart life

There are 2 ways to install TuyaSmart;

1. Search for “TuyaSmart life” in the APP store on your phone, download and install.
2. Scan the QR code below with your mobile phone.



WIFI SETTING AND FIREPLACE OPERATION

1. Create an account and log in.
2. When you log in, touch “+” (FIG.1) to enter in FIG.2. Touch “others” on the left corner first and then choose “Connector (Wi-fi)” to enter in FIG.3 to set your Wi-fi account and password.

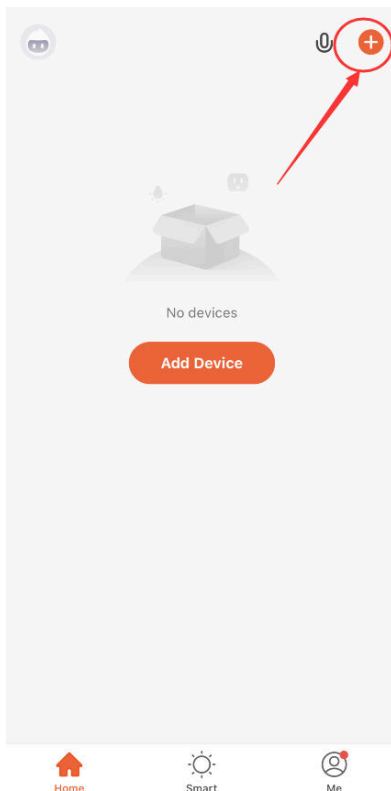

FIG.1



FIG. 2

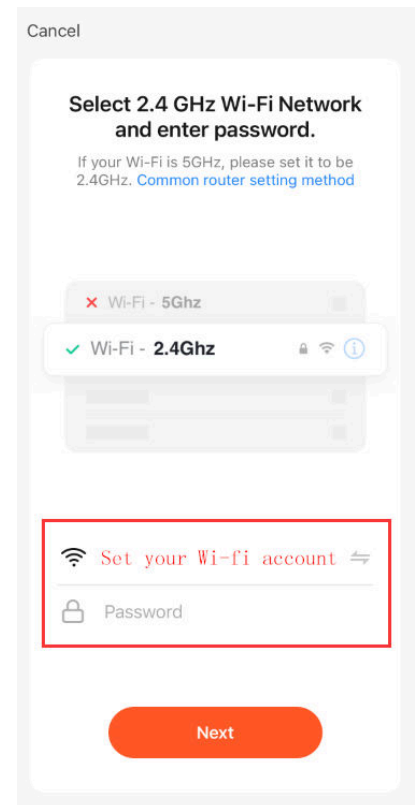



FIG.3



FIG.4

3. Press  (flame button) on the touch panel of the fireplace for more than 5 seconds when the fireplace is in standby mode. There will be 2 beeps come out from the fireplace and the  (flame button) will flash as well indicating that Wi-fi is in EZ mode. Then please confirm to go next. (FIG.5)
4. The APP will scan (FIG.6) and add the fireplace to APP (FIG.7) automatically. Please make sure the Wi-fi account and password you set are correct and Wi-fi signal is good.
5. Touch “Done” to finish Wi-fi setting.(FIG.7)

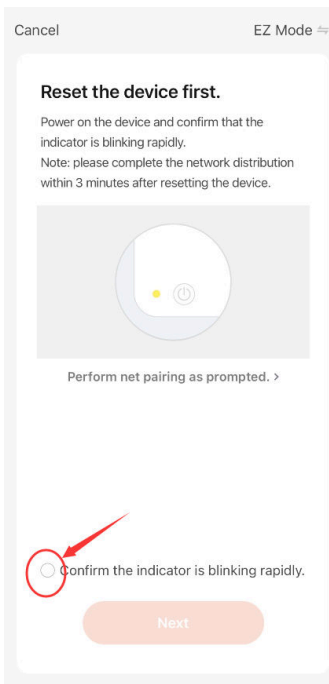

FIG.5

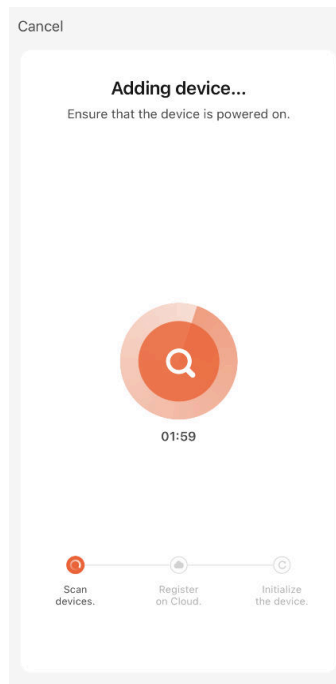

FIG.6

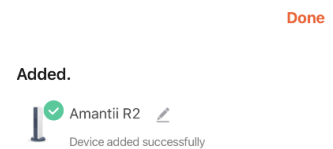

FIG.7

6. Now you are in the interface like FIG.7. You can operate the fireplace via Wi-fi.

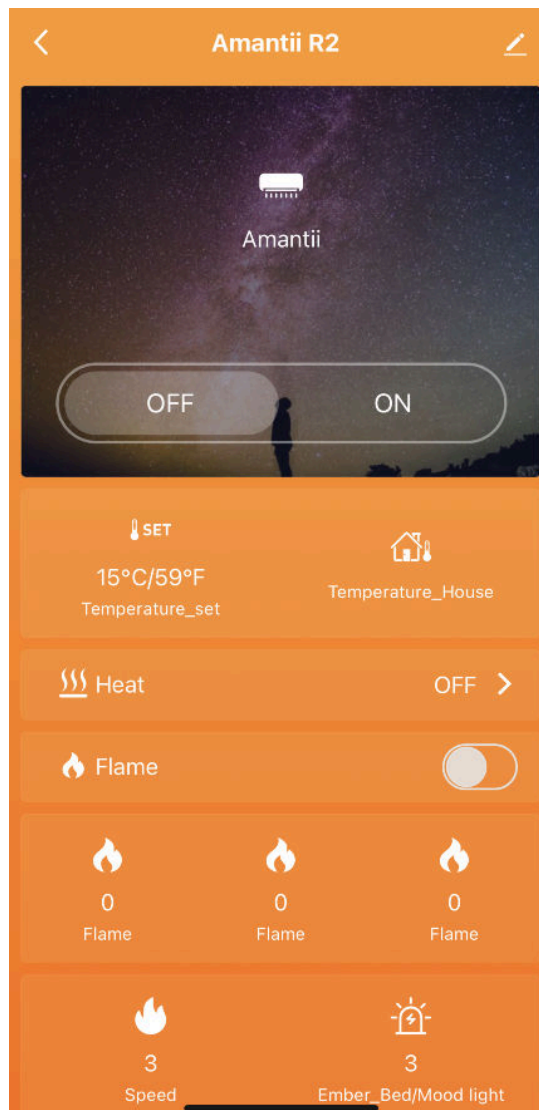

FIG.7

REPLACEMENT PARTS			
Reference No.	Description	Quantity	WM-BI-2428 VLR -BG - WiFi
1	Top Panel	1	
2	Back Top Panel	1	
3	Circuit Board	1	10124129
4	Blower & Heater Assembly	1	602082
5	Fireplace Box	1	601097
6	Canopy Light	1	601139B
7	Canopy Light Bracket	1	10104010
9	Signal Receiver	1	301506
10	Power Cord	1	10103007
11	Touch Panel	1	10124003
12	Flicker Assembly for Flame	1	3056504E
13	Flame LED Strip	1	601144
14	Tray LED Strip	1	601144
15	Flicker Assembly for Tray	1	3056503D
16	Tray Glass	1	10701200C
17	Side Bracket	1	10702150
18	Front Flat Glass	1	10701164
19	Remote	1	10101501
20	WiFi Card	1	212051

*Remote Control & WiFi Card are not shown in the exploded view

*Items may not appear exactly as illustrated

EXPLODED VIEW

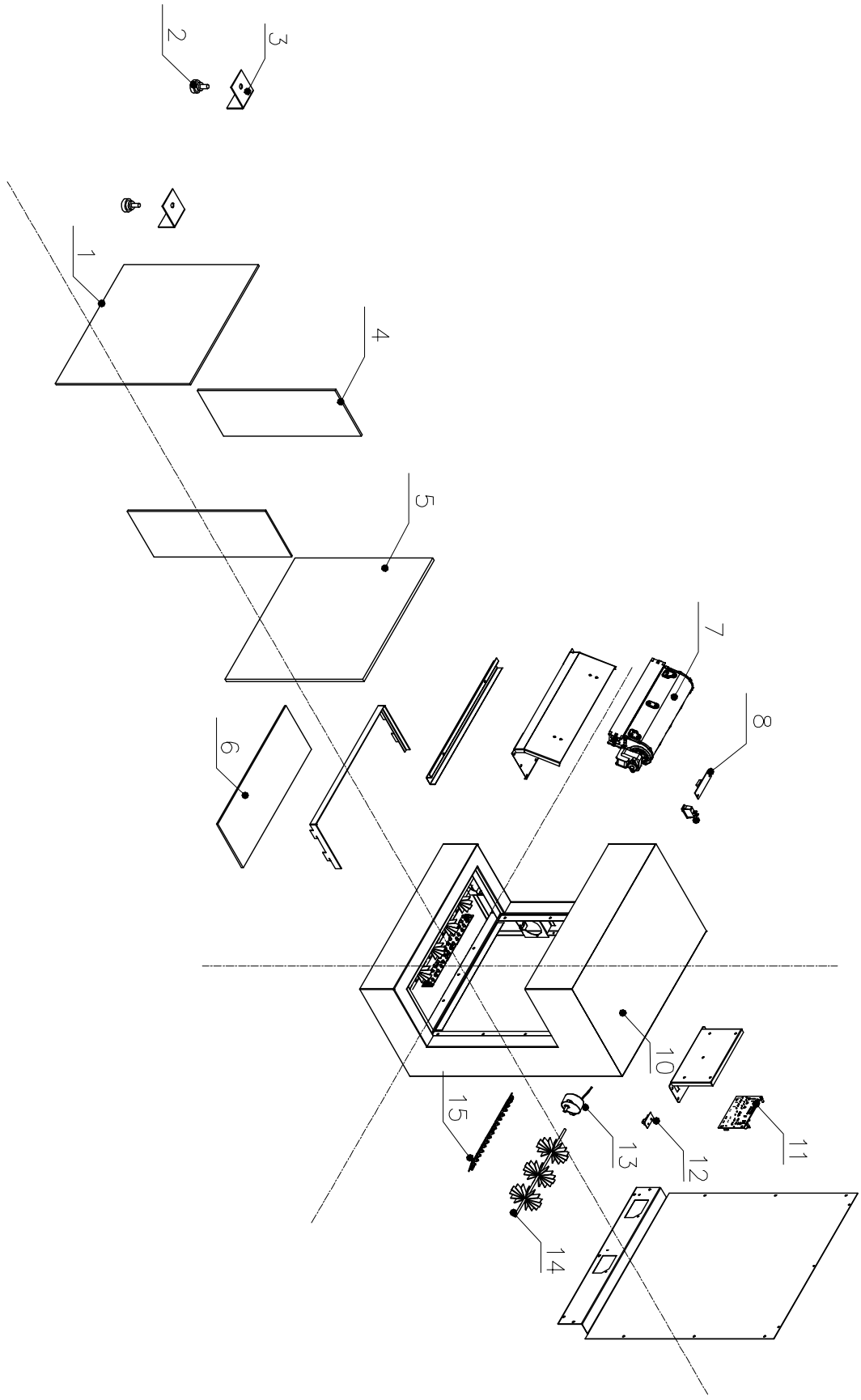

Wiring Diagram

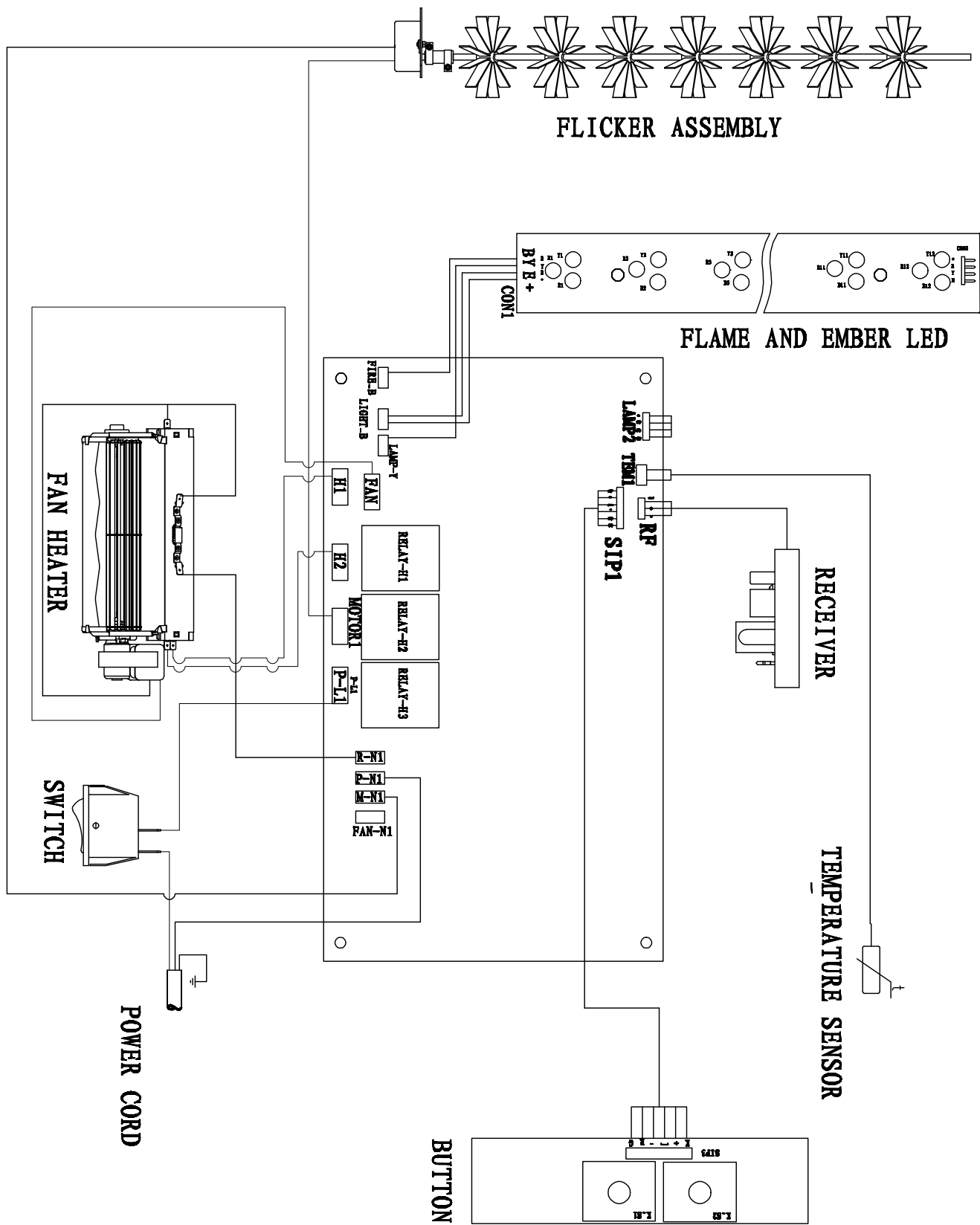

TROUBLE SHOOTING

PROBLEM	POSSIBLE CAUSE	SOLUTION
Dim or no flame	Flame LED's are burnt out.	Inspect the LED's and replace them if necessary.
	Back black cloth is falling off and rolled up in the flicker.	Change a flicker and back black cloth.
Ember bed is not glowing or dimming	Ember LED's are burnt out	Inspect the ember bed LED's and replace them if necessary.
Appliance turns off and will not turn on	Appliance has overheated, and safety device has caused the thermal switch to disconnect.	Turn off the main switch, allow appliance to cool for 10 minutes, turn back on.
	House circuit breaker has tripped.	Reset house circuit breaker.
	Appliance's fuse has blown.	Replace the fuse.
Appliance will not come on when switch is flipped to ON	Appliance is not plugged into an electrical outlet.	Check plug and plug in.
	Appliance has overheated and safety device has caused the thermal switch to disconnect.	Turn off the main switch, allow appliance to cool for 10 minutes, turn back on.
	Circuit board is burnt out.	Inspect the circuit board and replace it if necessary.
No warm air coming out of appliance	Heater is burnt out.	Inspect the burner and heater assembly and replace it if necessary.
Flame sputters	Flame motor is defective.	Call a qualified service technician and replace flame motor.
Remote Control does not work.	Low batteries. Unit switch in "O" position.	Replace AAA batteries in remote control. Turn the switch in "I" position.
Flame is fixed.	Wiring may be loose or the flame motor may be defective.	

SERVICE HISTORY

This heater must be serviced annually depending on usage.

Date	Dealer Name	Service Name	technician	Service Performed	Special Concerns

NOTES:

WARRANTY FOR PRODUCTS MANUFACTURED AFTER JANUARY 1st, 2016

Amantii Imports Corp. ("Amantii ") warrants that your newly purchased Amantii electric fireplace is free from manufacturing and material defects for a period of two (2) years from the date of the first purchase, subject to the conditions and limitations contained below.

Warranty Application & Exclusions

This limited warranty applies to your newly purchased Amantii electric fireplace; the limited warranty's application is limited to purchases made in any province of Canada or in any of the 52 States of the United States of America, including the District of Columbia. Only the original purchaser of the product is eligible for coverage under this limited warranty; the warranty is not transferable.

Products excluded from this limited warranty

Light bulbs are not covered by this limited warranty and are the sole responsibility of the owner/ purchaser. Amantii does not cover service or labor charges.

Warranty Coverage and Term

Products covered by this limited warranty have been tested and inspected prior to shipment and, subject to the provisions of this warranty, Amantii warrants such products to be free from defects in material and workmanship for a period of two (2) years from the date of the first purchase of such products.

The limited two (2) year warranty period for products also applies to any implied warranties that may exist under applicable law. Some jurisdictions do not allow limitations on how long an implied warranty lasts, so the above limitation may not apply to the purchaser.

All other warranties-expressed or implied-with respect to the product, its components and accessories or any obligation/liabilities on the part of Amantii are hereby expressly excluded.

Limitations to Coverage Under Limited Warranty

This limited warranty does not apply to products that have been repaired, except by Amantii or its authorized service representatives, or otherwise altered. This limited warranty further does not apply to defects resulting from misuse, abuse, accident, neglect, incorrect installation, improper maintenance or handling, or operation with an incorrect power source. Products made by other manufacturers, sold with the product or thereafter, are not covered by this limited warranty. The use of unauthorized components will render this warranty null and void.

Panorama Outdoor Units

All Panorama units that are installed outdoors or in moisture intense conditions must use the stainless steel cover. Proof of purchase of the cover is required for any warranty claims.

Defects

Defects must be brought to the attention of the selling dealer. Please have your proof of purchase, catalogue/model and serial numbers available when contacting dealer; any and all service under the limited warranty requires a proof of purchase of the product. Should a product or part covered by this limited warranty be proven to be defective, in material or workmanship, and during the two (2) year limited warranty period, Amantii will replace such defective product or part without charge. If Amantii is unable to replace such product, or if replacement is not commercially practicable or cannot be timely done, in its sole discretion Amantii may, in lieu of replacement, choose to refund the purchase price for such product or part. Amantii does not cover labor or service charges to replace said parts.

Limitations

In no event will Amantii, including without limitation any of its directors, officers, shareholders, employees, consultants, agents, heirs, executors, administrators and assigns, be liable to the purchaser or any third party, whether in contract, in tort, or on any other basis for any indirect, special, punitive, exemplary, consequential, or incidental loss, cost or damage arising out of or in connection with the sale, maintenance, use or inability to use the product, even if Amantii, including without limitation any of its directors, officers, shareholders, employees, consultants, agents, heirs, executors, administrators and assigns, have been advised of the possibility of such losses, costs or damages, or if such losses, costs or damages are foreseeable. In no event will Amantii, including without limitation any of its directors, officers, shareholders, employees, consultants, agents, heirs, executors, administrators and assigns, be liable for any direct losses, costs or damages that exceed the purchase price of the product.

Some jurisdictions do not allow the exclusion or limitation of incidental or consequential damages, so the above limitation or exclusion may not apply to the purchaser.

Application of Provincial and State Law

This limited warranty gives you specific legal rights, and you may also have other rights which vary from jurisdiction to jurisdiction. The provisions of the United Nations Convention on Contracts for the Sale of Goods shall not apply to this limited warranty or the sale of products covered by this limited warranty.

General

Amantii reserves the right to make changes at any time without notice, in design, material, specifications, prices and the right to discontinue styles and products.