



N A P O L E O N<sup>®</sup>

# Prestige Collection

Direct Vent  
Gas Fireplaces



QUALITY FIREPLACES  
*Award Winning Products*

# N A P O L E O N<sup>®</sup>

*The Comfort You Deserve*

With over 30 years of passionate dedication, Napoleon<sup>®</sup>, an industry leader for innovative designs, has earned a worldwide reputation for providing families with fireplaces of uncompromising quality, state-of-the-art technology and designer features that create a proud statement in any home.

As the largest family owned hearth manufacturer in North America, Napoleon<sup>®</sup> holds strong family values that carry through in every aspect of the organization. Since 1976, Napoleon<sup>®</sup> has grown from a small manufacturing operation to a large private corporation, instilling the same strong values they started with. Napoleon<sup>®</sup> products are found in homes around the globe... becoming the preferred choice worldwide.

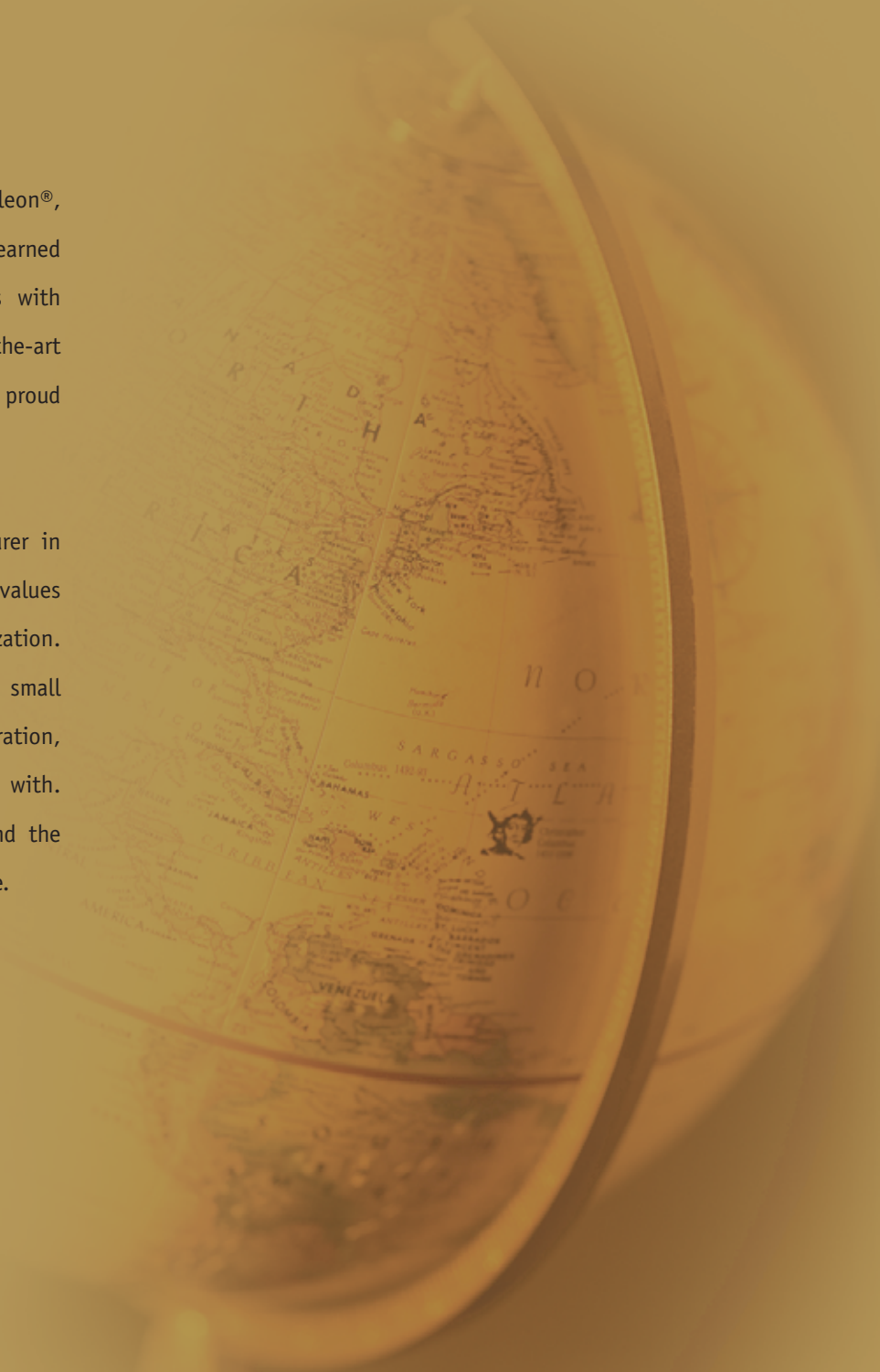

# WHY NAPOLEON®?

## **Making your life easier...**

Napoleon's Prestige Collection is designed to provide you absolute comfort and control at the touch of your fingertips. It's that easy. When you install a Napoleon® direct vent gas fireplace, you can rest assured that you will enjoy a lifetime of instant ambiance with reliable performance year after year.

## **An investment you can count on...**

Your new Napoleon® fireplace adds value to your home while at the same time giving you uncompromising comfort and a reliable heating source. Aside from kitchen and bathroom renovations, fireplaces add the most return on your home investment. Nothing to lose and everything to gain.

## **Create your personal design statement...**

Surround yourself with a home environment that makes you feel good, relaxed and proud to reflect your decorating style. Thousands of designer options are available to create the exact statement you have been looking for.

## **Highest efficiencies, maximum comfort...**

Years of research, design and testing have enhanced optimum performance allowing Napoleon® products to achieve some of the highest heater rating efficiencies on the market. Napoleon® continuously surpasses industry standards not only in appearance but in efficiency and performance.

## **Beautiful fires, best flame in the industry...**

With advanced burner technology and innovative design, Napoleon's flame and exclusive PHAZER® log sets are so realistic it's hard to tell the difference from a real wood burning fire.

## **Authorized dealer support network...**

With over 3,000 reputable authorized dealers across North America and Europe, Napoleon® provides professional and consistent training and technical support to ensure your fireplace is installed by a certified, reputable installation technician.

## **Outstanding Reliable Warranty...**

Each and every Napoleon® fireplace is designed and manufactured to strict quality testing standards and backed by the President's Limited Lifetime Warranty, guaranteed to give you the solid performance you deserve. (Registered under the world recognized ISO 9001-2000)

## **Mantel Selection...**

Napoleon® offers a complete selection of wood and architectural cast stone mantel packages. Ask your dealer for details or view online at [napoleonfireplaces.com](http://napoleonfireplaces.com).

 Only Napoleon® offers you these exclusive features. Watch for this symbol throughout the brochure.



**QUALITY FIREPLACES**  
*Award Winning Products*

[napoleonfireplaces.com](http://napoleonfireplaces.com)

Napoleon® Waterfall Collection  
& Outdoor Living Products - Creating  
A Healthy, Relaxing Atmosphere

Napoleon® Architectural Cast Stone  
Mantels - Surrounding Yourself With  
Natural Beauty

(Background tile available through local tile outlets)

Napoleon® Quality Fireplaces,  
Inserts & Stoves - Instant Comfort  
& Ambiance





STARfire™ shown with painted black louvers, set in Napoleon's Marcella architectural cast stone mantel. Napoleon's 3'x6' waterfall also shown.

The Dream™ BGD90

*Everything you've dreamed of and more...*



**Remote**

Hand-held modulating  
thermostatic  
remote control  
included

This colossal fireplace has the phenomenal viewing area of 16 square feet, sure to capture anyone's attention who may enter the room. With its astounding design, the Dream™ is the perfect fireplace to make a statement in any home. Ideal for a great room, large bedroom, ski lodge, lobby or castle. Napoleon® is extremely pleased to offer such an extraordinary fireplace for discriminating customers who want to set themselves apart.



**QUALITY FIREPLACES**  
*Award Winning Products*

## Optional Decorative Accessories



Optional solid wrought iron decorative square frame with arched rail inset



Optional solid wrought iron rectangular "Artisan" double doors



Optional country crane and hearth pot



Remote Control  
(Included)

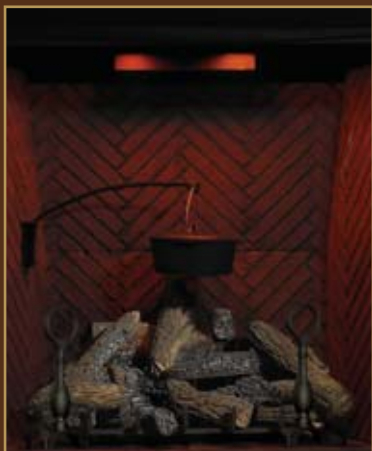

**Dual Night Light™**  
(Included)



# The Dream™

## Napoleon® Exclusive Features

- 🔥 • **Exclusive Napoleon® Night Light™** radiates a warm glow to the room even when the fireplace is off
- 🔥 • **An unbelievable 16 sq. ft. viewing area - One of the largest in the industry**
- 🔥 • **Double burner system showcasing two incredible levels of intense YELLOW DANCING FLAMES®**
- 🔥 • **Exclusive PHAZER® logs with a natural wood appearance**
  - Traditional clean face masonry design and feel
  - 50% flame/heat adjustment for maximum comfort and efficiency
  - Millivolt system ensures reliable use even during power failures
  - 100% SAFE GUARD™ gas control system automatically and quickly shuts off the gas supply for your peace of mind
  - Zero clearance to combustibles
  - Convenient hand-held thermostatic remote (controlling blower, flame intensity, temperature and Night Light™)
  - Exquisite Sandstone Herringbone decorative brick panels
  - Solid cast iron decorative andirons in painted black included with the unit
  - Controls are concealed from view but easily accessible
  - Available as a natural gas or propane unit
  - Approved for bathrooms, bedrooms, bed sitting rooms and mobile homes
  - Optional solid wrought iron decorative square frame with arched rail inset
  - Optional solid wrought iron rectangular “Artisan” double doors
  - Optional remote blower kit for WHISPER QUIET™ operation
  - Optional country crane and hearth pot
  - Backed by President’s Lifetime Limited Warranty

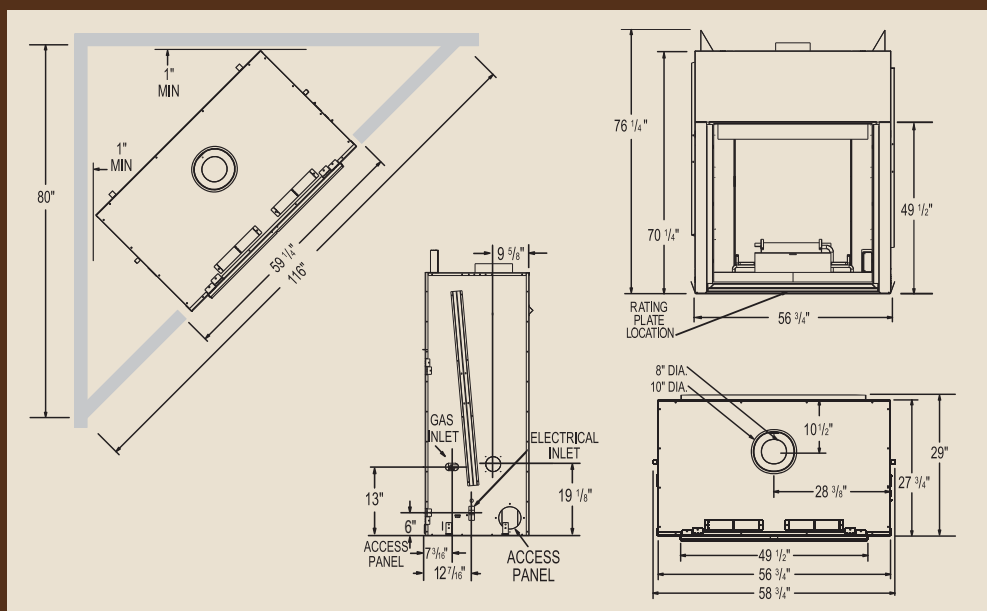

Napoleon® Exclusive Feature

| Model | BTU'S (Input) | Venting<br>8" & 10" | Height  |         | Front Width |         | Depth   |         |
|-------|---------------|---------------------|---------|---------|-------------|---------|---------|---------|
|       |               |                     | Actual  | Framing | Actual      | Framing | Actual  | Framing |
| BGD90 | 50,000        | Top                 | 49 1/2" | 76 1/2" | 49 1/2"     | 59 1/4" | 27 3/4" | 29"     |

| Model | Glass Type | Glass Size |         | Efficiencies |      |              | Blower   | Mobile Home Certified |
|-------|------------|------------|---------|--------------|------|--------------|----------|-----------------------|
|       |            | Height     | Width   | EnerGuide    | AFUE | Steady State |          |                       |
| BGD90 | Tempered   | 49 1/2"    | 49 1/2" | 60.9%        | -    | 63%          | Optional | Yes                   |

Certified under Canadian and American National standards CSA 2.22, ANSI, Z21.50 for vented gas fireplaces. Consult your owner's manual for complete and up-to-date installation instructions and proper clearances to combustible materials.



HD81 See-Thru

*One fireplace, two rooms, exceptional views*



**Remote**

Hand-held modulating  
thermostatic  
remote control  
included

The HD81 is the first see-thru direct vent fireplace in the industry to offer such dynamic choices for firebox design options. Besides supplying two rooms with exceptional focal points, the HD81 also offers the choice of a traditional PHAZER® log set, a modern crystal ember bed or glowing river rock setting. Any of these 3 design choices create an exciting environment for any home.



**QUALITY FIREPLACES**  
*Award Winning Products*

## Firebox Options



PHAZER® log set



Contemporary CRYSTALINE™ setting



Contemporary River Rock Setting

## Decorative Panels



Sandstone  
Brick Panels



Porcelain Reflective  
Radiant Panels

## Coloured Glass Options



Amber



Black



Blue



Red

## Andirons



Painted Black  
Andirons

## Burner Trim

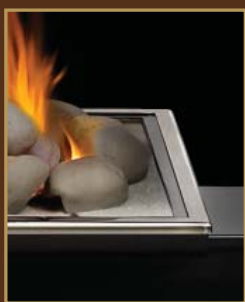

Polished Chrome  
Accent Trim



# HD81 See-Thru

## Napoleon® Exclusive Features

- 🔥 • **Exclusive Napoleon® Night Light™** radiates a warm glow to the room even when the fireplace is off
- 🔥 • **Innovative, split burner system** produces a beautiful **YELLOW DANCING FLAME®** pattern and provides a huge heating range from 22,000 BTU's to 60,000 BTU's
- 🔥 • **Optional quiet, remote, high output blower system** pushes the heat out from above the door openings with **SPLIT ZONE™** control - see diagram
- 🔥 • **Choice of Napoleon's traditional PHAZER® logs or CRYSTALINE™ crystals or River Rock ember beds**
- 🔥 • **Exclusive anti-condensation switch (ACS)**
  - See-thru, clean face design can be enjoyed from two separate rooms
  - Fuel saving electronic ignition
  - Convenient hand-held remote, controlling the flame, blower and dual Night Light™ comes standard with the unit
  - Perfect for residential or commercial use
  - Clear glass comes standard with CRYSTALINE™ ember bed - optional coloured glass is available
  - Optional Porcelain Reflective Radiant Panels or decorative Sandstone Brick Panels are available
  - Optional Power Vent kit makes difficult installation locations possible with added flex vent and termination versatility
  - Optional polished chrome burner accent trim (CRYSTALINE™ and Rock burner only)
  - Certified for bathrooms, bedrooms, bed sitting rooms and mobile homes
  - Backed by President's Lifetime Limited Warranty

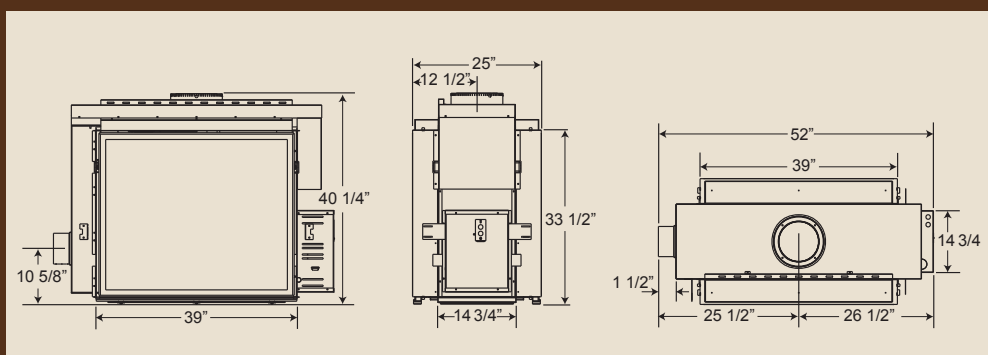
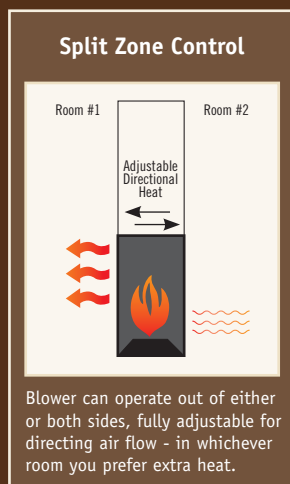

 Napoleon® Exclusive Feature

| Model | BTU'S (Input) | Venting 8" & 10" | Height  |         | Front Width |         | Depth  |         |
|-------|---------------|------------------|---------|---------|-------------|---------|--------|---------|
|       |               |                  | Actual  | Framing | Actual      | Framing | Actual | Framing |
| HD81  | 60,000        | Top              | 40 1/4" | 49 1/4" | 52"         | 54 1/2" | 25"    | 25"     |

| Model | Glass Type | Glass Size |         | Efficiencies |        |              | Blower   | Mobile Home Certified |
|-------|------------|------------|---------|--------------|--------|--------------|----------|-----------------------|
|       |            | Height     | Width   | EnerGuide    | AFUE   | Steady State |          |                       |
| HD81  | Ceramic    | 30 3/4"    | 36 3/4" | 64%          | 64.5 % | 67%          | Optional | Yes                   |

Certified under Canadian and American National standards: CSA 2.33, ANSI Z21.88 for vented gas fireplace heaters. Consult your owner's manual for complete and up-to-date installation instructions and proper clearances to combustible materials.

The Madison™ GD80

*Old world charm... With tomorrow's technology*



**Remote**

Hand-held modulating  
thermostatic  
remote control  
included

The Madison™ rekindles the romantic era when sitting by the fire melted away the chills of the world outside. The traditional aesthetics provide an exceptional, unobstructed viewing area with a frameless finish. An open look of a real wood burning fireplace emerges with all the conveniences of direct vent technology. This exclusive fireplace comes fully equipped with a multi-function hand-held remote control (adjusting flame, heat, blower and exclusive Night Light™), elegant solid cast iron andirons and grate, heat circulating blower, safety pull screen and advanced burner technology. All this and the choice of either a wrought iron faceplate or a traditional arch or rectangular door design to complement your decor.



**QUALITY FIREPLACES**  
*Award Winning Products*

# Optional Door Kits



Hand Forged Iron - Solid Handcrafted Wrought Iron Faceplate Complete With Double Arched Doors



Hammertone Pewter Finish



Hammertone Copper Finish



Arched Hammertone Copper Finish Door



Arched Hammertone Pewter Finish Door



Rectangular Hammertone Copper Finish Door



Rectangular Hammertone Pewter Finish Door

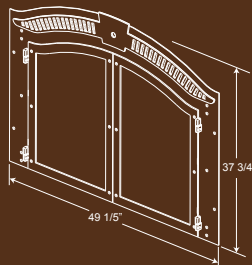
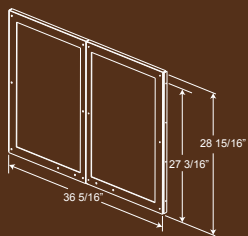
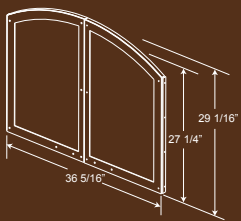

## Decorative Panels



Sandstone Herringbone Panels



Old Town Red™ Brick Panels



Sandstone Brick Panels



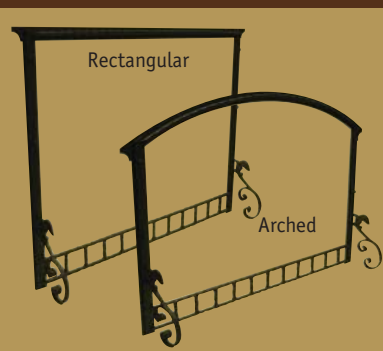

Porcelain Reflective Radiant Panels

## Decorative Frames



# The Madison™

## Napoleon® Exclusive Features

-  • **Exclusive Napoleon® Night Light™** radiates a warm glow to the room even when the fireplace is off
  -  • **PHAZERAMIC™** advanced burner technology with glowing ember bed produces the most realistic flames in the industry
  -  • **Efficient Heat Exchanger;** Napoleon's exclusive heat catalyzing chamber draws cool room air in, forcing it around the entire hot firebox and back out in the room with a high output heat circulating blower system, standard with every Madison™
- Immense 37" w x 30" h viewing area
  - Available in either a true arch or rectangular design opening
  - Realistic PHAZER® logs, distinctive to The Madison™, provide real wood log appearance
  - 100% SAFE GUARD™ gas control system automatically and quickly shuts off the gas supply for your peace of mind
  - 50% flame/heat adjustment for maximum comfort and efficiency
  - Superior heat circulating blower with variable speed control provides powerful heating performance
  - Elegant cast iron andirons & grate come standard with the unit
  - Full view operable safety screen
  - Hand-held modulating thermostatic remote (controls flame, heat, blower and Night Light™)
  - No electricity required to light or operate - millivolt system ensures reliable use even during power failures
  - Approved for bathrooms, bedrooms, bed sitting rooms and mobile homes
  - Backed by President's Lifetime Limited Warranty

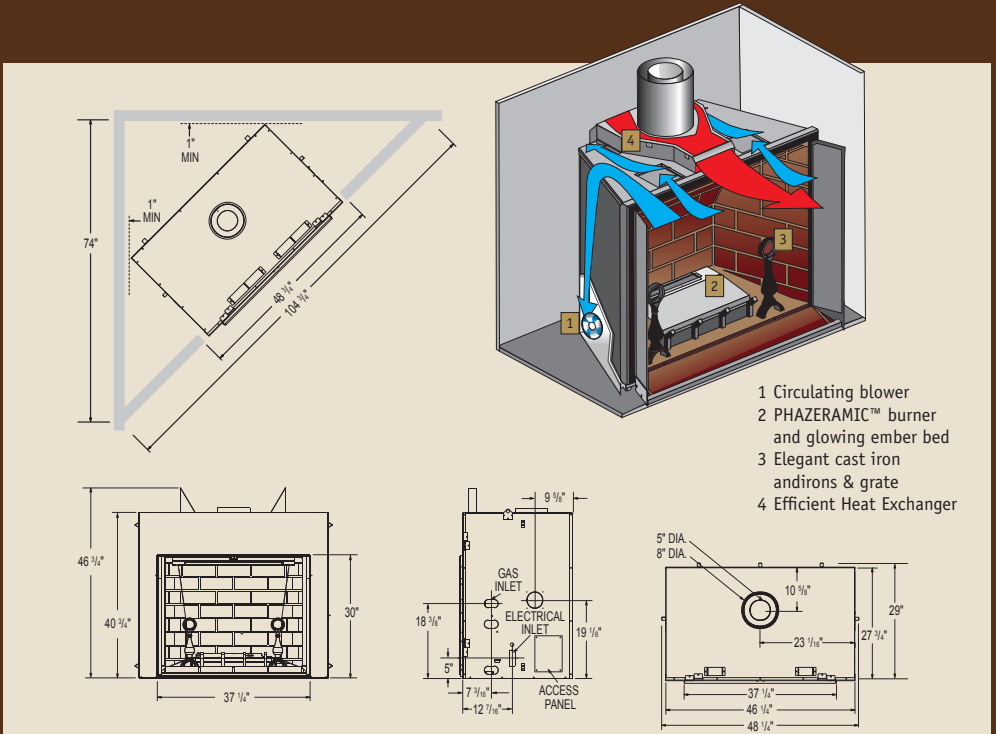

 Napoleon® Exclusive Feature

| Model | BTU'S (Input) | Venting 5" & 8" | Height    |         | Front Width |         | Depth   |         |
|-------|---------------|-----------------|-----------|---------|-------------|---------|---------|---------|
|       |               |                 | Actual    | Framing | Actual      | Framing | Actual  | Framing |
| GD80  | 43,000        | Top             | 40 11/16" | 46 3/4" | 46 1/4"     | 48 3/4" | 27 3/4" | 29 1/4" |

| Model | Glass Type | Glass Size |       | Efficiencies |      |              | Blower   | Mobile Home Certified |
|-------|------------|------------|-------|--------------|------|--------------|----------|-----------------------|
|       |            | Height     | Width | EnerGuide    | AFUE | Steady State |          |                       |
| GD80  | Ceramic    | 30"        | 37"   | 51.4%        | -    | 78%          | Included | Yes                   |

Certified under Canadian and American National standards: CSA 2.33, ANSI Z21.88 for vented gas fireplace heaters. Consult your owner's manual for complete and up-to-date installation instructions and proper clearances to combustible materials.

# The STARfire™ GD70

*Affordable luxury*



Shown with painted black decorative faceplate complete with operable safety screen doors and Old Town Red™ brick panels.

The STARfire™ GD70 offers you a wide range of heat output and control with a remarkable 50% flame/heat adjustment and an outstanding 81% efficiency rating. A 35,000 BTU burner provides cozy heat with a stunning YELLOW DANCING FLAME® pattern! With a 682 square inch viewing area, the STARfire™ is a one of a kind fireplace that you will be proud to show to family and friends! The perfect fit for great rooms and larger family rooms.

Left: Also shown is Napoleon's 3'x6' waterfall with mirrored background. See dealer for details.



**QUALITY FIREPLACES**  
*Award Winning Products*

# Optional Decorative Accessories

## Decorative Panels



Sandstone Herringbone Panels



Old Town Red™ Brick Panels



Sandstone Brick Panels



Porcelain Reflective Radiant Panels



## Bayfront

Bay Front shown with painted black Heritage Ornamental Insets and cast iron surround. Fully operational safety fire screen for that masonry look and feel!

## Trims



3" trim kit available in polished brass finish, brushed stainless steel finish



3" bevelled trim available in painted black, antique brass finish, polished brass finish and brushed stainless steel finish



6" bevelled trim available in painted black, antique brass finish, polished brass finish and brushed stainless steel finish

## Doors



Painted Black



24 Karat Gold Plated



Brushed Stainless Steel Finish



## Remote

Hand-held modulating thermostatic remote control

## Ornamental Insets



Heritage



Diamond



Eclipse



Seashell



Gothic

## Andirons



24 Karat Gold Plated



Painted Black

## Louvres



Polished Brass Finish



Brushed Stainless Steel Finish

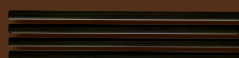

Painted Black



Antique Brass Finish

## Cast Iron Surround

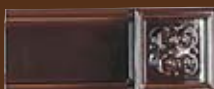

Porcelain Majolica Brown



Porcelain Black



Traditional Painted Black



Porcelain Majolica Green





# The STARfire™

## Napoleon® Exclusive Features

- Exclusive Napoleon® Night Light™ radiates a warm glow to the room even when the fireplace is off
- PHAZERAMIC™ advanced burner technology with glowing ember bed, produces the most realistic flames in the industry
- Realistic PHAZER® logs, rich in colour and detail, provide a real wood log appearance
- 50% flame/heat adjustment for maximum comfort and efficiency
- 100% SAFE GUARD™ gas control system automatically and quickly shuts off the gas supply for your peace of mind
- Superior heat circulating blower with variable speed and thermostatic control provides powerful heating performance
- Approved for bathrooms, bedrooms, bed sitting rooms and mobile homes
- Backed by President's Limited Lifetime Warranty



### Optional decorative faceplates

A -Ornamental face plate designed for marble/tile backing  
 B -Ornamental face plate designed for flush wall installation  
 Ornamental face plates (A&B) available in painted black, 24 karat brushed gold plated and 24 karat gold plated

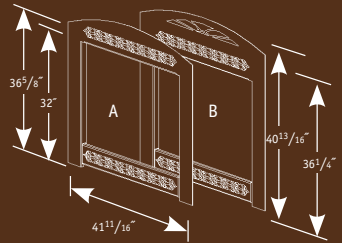

Hammertone pewter



Hammertone copper



Painted black

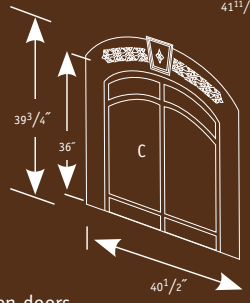

Decorative face plate (C) complete with operable safety screen doors available in painted black, hammertone copper and hammertone pewter.

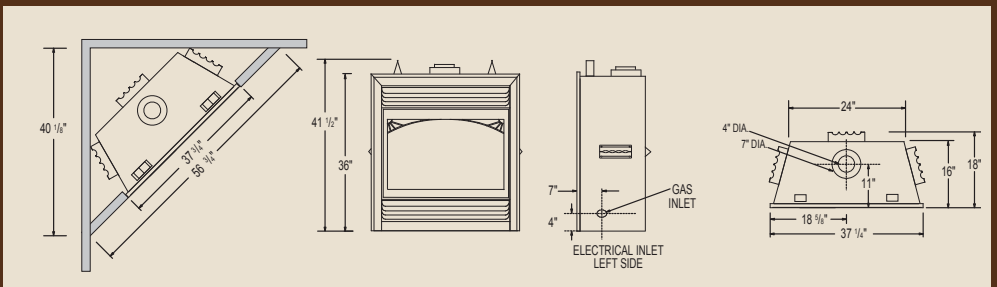

 Napoleon® Exclusive Feature

| Model | BTU'S (Input) | Venting 4" & 7" | Height |         | Front Width |         | Depth  |         |
|-------|---------------|-----------------|--------|---------|-------------|---------|--------|---------|
|       |               |                 | Actual | Framing | Actual      | Framing | Actual | Framing |
| GD70  | 35,000        | Top             | 36"    | 41 5/8" | 37 1/4"     | 37 3/4" | 16"    | 18 1/4" |

| Model | Glass Type | Glass Size |         | Efficiencies |      |              | Blower   | Mobile Home Certified |
|-------|------------|------------|---------|--------------|------|--------------|----------|-----------------------|
|       |            | Height     | Width   | EnerGuide    | AFUE | Steady State |          |                       |
| GD70  | Ceramic    | 23"        | 31 5/8" | 53.6%        | 72%  | 81%          | Included | Yes                   |

Certified under Canadian and American National standards: CSA 2.33, ANSI Z21.88 for vented gas fireplace heaters. Consult your owner's manual for complete and up-to-date installation instructions and proper clearances to combustible materials.

The Park Avenue™ GD82

*Tall, slender, European design*



**Remote**

Hand-held modulating  
thermostatic  
remote control  
included

Shown with Sandstone Herringbone decorative  
brick panels, arched facing kit with Heritage pattern and  
traditional painted black andirons.

This tall, dark, handsome fireplace features a unique, clean, frameless design with advanced burner technology, creating the most realistic flames in the industry. The Park Avenue™ deluxe model is offered as a complete package including an exclusive Night Light™, heat circulating blower, hand-held remote (controlling the flame, blower and Night Light™), and PHAZERAMIC™ advanced flame burner technology.



**QUALITY FIREPLACES**  
*Award Winning Products*

## Arched Facing Kits



Arched facing kit with lattice pattern in hand forged wrought iron



Arched facing kit with heritage pattern in painted black finish

## Stainless Steel Surround & Hearth



Napoleon's stainless steel surround and hearth

## Optional Rectangular Facing Kits



Rectangular Facing Kit in Painted Black Finish

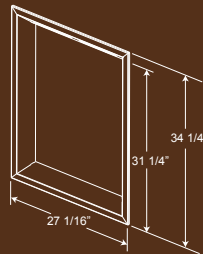
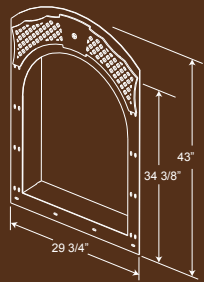

## Decorative Panels



Fluted Refractory Bricks in Sandstone Finish



Fluted Refractory Bricks with Napoleon® insignia in Sandstone Finish



Sandstone Herringbone Decorative Brick Panels

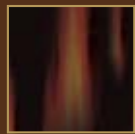

Porcelain Reflective Radiant Panels

## Andirons



Traditional Painted Black Andirons



Obelisk Painted Black Andirons



## Napoleon® Exclusive Features

- Exclusive Napoleon® Night Light™ radiates a warm glow to the room even when the fireplace is off
- PHAZERAMIC™ advanced burner technology with glowing embers provides the most realistic flame in the industry
- 50% flame/heat adjustment creates a perfect atmosphere with just the right amount of heat needed
- Your choice of exclusive designer accessories to suit any decor
- Multi-function remote, controlling the flame, blower & Night Light™, is included with the unit
- 100% SAFE GUARD™ gas control system automatically and quickly shuts off the gas supply for your peace of mind
- Superior heat circulating blower with variable speed provides powerful heating performance
- Approved for use in bathrooms, bedrooms, bed sitting rooms and mobile homes
- No electricity required to light or operate - millivolt system ensures use even during power failures
- Backed by President's Limited Lifetime Warranty



Living Rooms



Bedrooms



Bathrooms



Kitchens

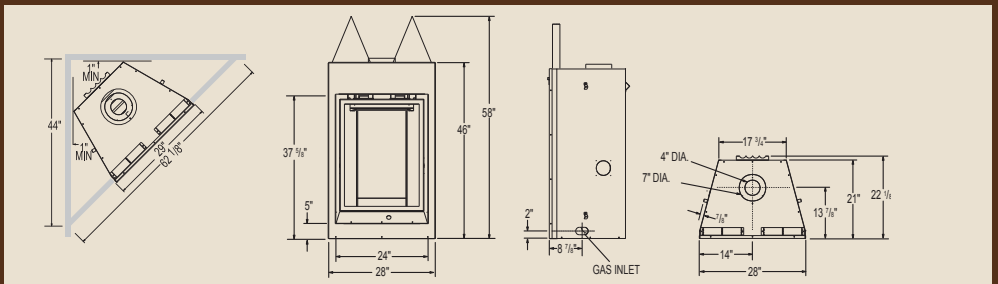

Napoleon® Exclusive Feature

| Model | BTU'S (Input) | Venting<br>4" & 7" | Height |         | Front Width |         | Depth  |         |
|-------|---------------|--------------------|--------|---------|-------------|---------|--------|---------|
|       |               |                    | Actual | Framing | Actual      | Framing | Actual | Framing |
| GD82  | 26,000        | Top                | 46"    | 58 1/2" | 28"         | 29"     | 21"    | 22 1/2" |

| Model | Glass Type | Glass Size |       | Efficiencies |      |              | Blower   | Mobile Home Certified |
|-------|------------|------------|-------|--------------|------|--------------|----------|-----------------------|
|       |            | Height     | Width | EnerGuide    | AFUE | Steady State |          |                       |
| GD82  | Ceramic    | 29"        | 22"   | 54.4%        | 62%  | 73%          | Included | Yes                   |

Certified under Canadian and American National standards: CSA 2.33, ANSI Z21.88 for vented gas fireplace heaters. Consult your owner's manual for complete and up-to-date installation instructions and proper clearances to combustible materials.

The Tureen™ GD82-T

*Contemporary, modern elegance*



**Remote**

Hand-held modulating  
thermostatic  
remote control  
included

Combining style, modernism and elegance into one fireplace, Napoleon® is excited to include the Tureen™ to the Prestige Collection of fireplaces. A totally unique European style, showcasing a contemporary ceramic bowl, accented with stylish river rocks and a towering flame. It's impressive design is certain to create a dynamic and extraordinary focal point wherever it is installed.



**QUALITY FIREPLACES**  
*Award Winning Products*

## Decorative Options



Napoleon's stainless steel surround and hearth

## Facing Kits



Taupe Finish



Brown Finish



Pewter Finish



Black Finish



Rectangular facing kit available in painted black, brown, taupe and pewter

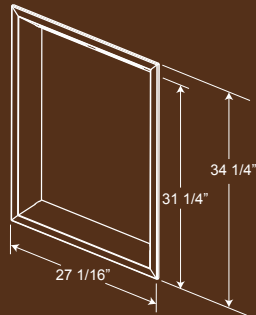

Arched facing kit with heritage pattern available in painted black



Arched facing kit with lattice pattern available in hand forged, solid wrought iron

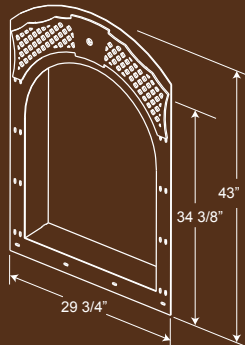

# The Tureen™

## Napoleon® Exclusive Features

- 🔥 • **Exclusive Napoleon® Night Light™** radiates a warm glow to the room even when the fireplace is off
- 🔥 • **The remarkable towering flame is created by the Tureen's unique heavy gauge Medallion™ burner system**
- 🔥 • **Double fired ceramic bowl, complemented with stylish refractory river rocks**
  - 50% flame/heat adjustment for maximum comfort and efficiency
  - Concave polished satin chrome reflective panel
  - Heat resistant high temperature ceramic glass door
  - No electricity required to light or operate - millivolt system ensures reliable use even during power failures
  - 100% SAFE GUARD™ gas control system automatically and quickly shuts off the gas supply for your peace of mind
  - Zero clearance to combustibles
  - Controls are concealed from view but easily accessible
  - Convenient hand-held thermostatic remote (controlling blower, flame intensity, temperature and Night Light™) comes standard with the unit
  - Available as a natural gas or propane unit
  - Superior heat circulating blower with variable speed provides powerful heating performance
  - Approved for use in bathrooms, bedrooms, bed sitting rooms and mobile homes
  - Backed by President's Limited Lifetime Warranty

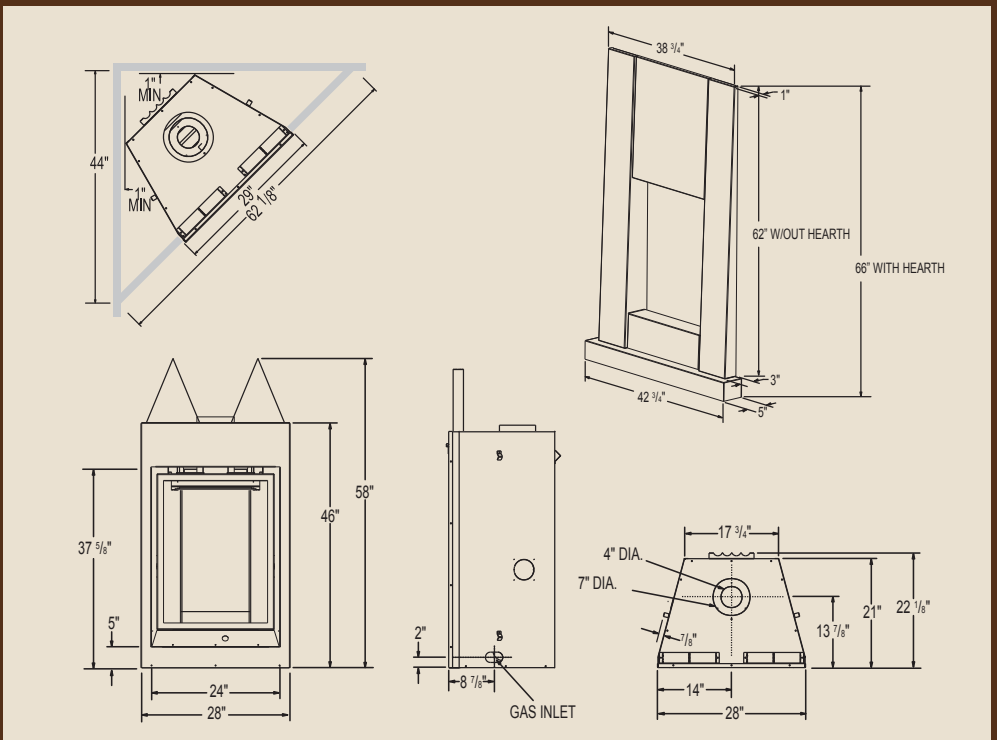

 Napoleon® Exclusive Feature

| Model  | BTU'S (Input) | Venting<br>4" & 7" | Height |         | Front Width |         | Depth  |         |
|--------|---------------|--------------------|--------|---------|-------------|---------|--------|---------|
|        |               |                    | Actual | Framing | Actual      | Framing | Actual | Framing |
| GD82-T | 26,000        | Top                | 46"    | 58 1/2" | 28"         | 29"     | 21"    | 22 1/2" |

| Model  | Glass Type | Glass Size |       | Efficiencies |      |              | Blower   | Mobile Home Certified |
|--------|------------|------------|-------|--------------|------|--------------|----------|-----------------------|
|        |            | Height     | Width | EnerGuide    | AFUE | Steady State |          |                       |
| GD82-T | Ceramic    | 29"        | 22"   | 54.4%        | -    | 62%          | Included | Yes                   |

Certified under Canadian and American National standards: CSA 2.33, ANSI Z21.88 for vented gas fireplace heaters. Consult your owner's manual for complete and up-to-date installation instructions and proper clearances to combustible materials.









# Outstanding Features of Napoleon's Advanced Technology



## PHAZERAMIC™ Burner System

Napoleon's sophisticated PHAZERAMIC™ infrared burner system offers superior flame technology. Strategically placed burner ports combined with realistic log sets create the most realistic flames in the industry.

Legend

-  Heat Radiating Infrared PHAZERAMIC™ Burner System
-  Includes Heat Circulating Blower
-  Radiant Heat
-  Full Function Digital Remote
-  No Electricity Required to Light or Operate
-  Money Saving
-  Built-in Night Light™
-  Zone Heating
-  Napoleon® Exclusive Feature



## Finely Tuned Precision Valves

Surrounded with a protective cast aluminum jacket, the precision valves allow for ultimate reliability and 100% SAFE GUARD™ gas control system.







#### True Masonry Details

Napoleon's ceramic brick panels with true masonry texture and mortar details, help transfer additional heat, radiating out from the firebox.



#### Outstanding Craftsmanship

Distinctive hand-forged wrought iron is a hallmark of Napoleon® artisans. Fine details are designed in every aspect of Napoleon® fireplaces.



#### High Heat Ceramic Glass

Ceramic glass is made to withstand extreme high temperatures, allowing maximum radiant heat performance & safety.



#### WHISPER QUIET™ Heat Circulating Blower System

The extreme heat resistant "H" class bearings featured in Napoleon's superior heat circulating blower, creates a lasting "whole home" comfort with adjustable high & low speeds.



#### Solid Hinged Doors

Manufactured with heavy gauge steel, the doors are conveniently hinged or pivoted for easy opening access with two snap clips.

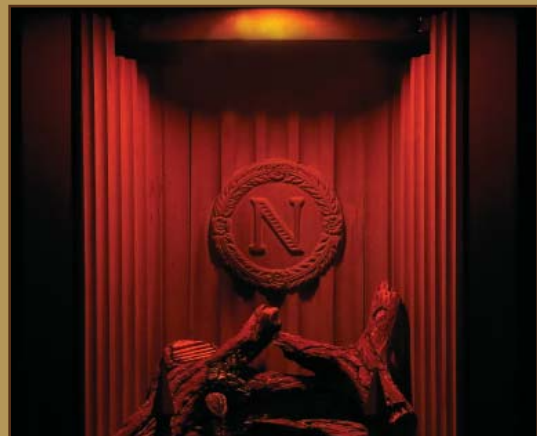

#### Exclusive Night Light™

The exclusive Night Light™ illuminates the whole decorative firebox, including the logs, even when the fireplace is turned off.

# Napoleon's Direct Vent Technology

## Convenient, Clean, Reliable Heating Source

With over 30 years of research and development, Napoleon® Fireplaces have perfected direct vent technology to offer you a fireplace, stove or insert that easily fits into your lifestyle.

With Napoleon's direct vent technology, you can design and install your fireplace in unique locations where it wasn't possible before with traditional masonry fireplaces. Even your basement can be transformed into a warm, inviting oasis for your family and friends to enjoy.

Whether you are renovating, building or replacing an inefficient fireplace product, Napoleon® helps guide you in the right direction to find the product that's right for you and your home. Napoleon® Fireplaces are a smart investment that will bring many years of affordable luxury to you and your family.

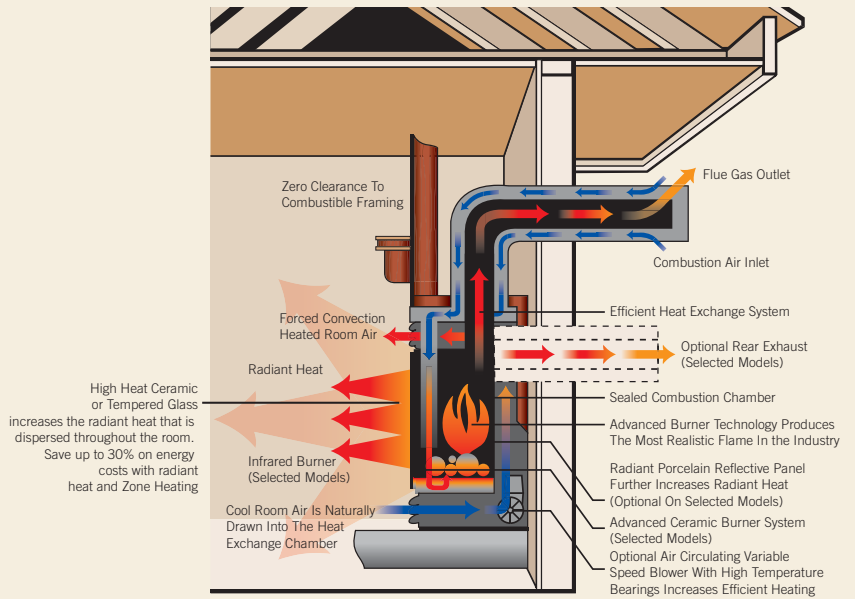

100% SAFE GUARD™ gas control system automatically and quickly shuts off the gas supply for your peace of mind.



Napoleon's Environmentally Friendly Products are designed to provide a clean burning, convenient natural gas or propane energy source - indoors and out.



Zone heating means you are heating the room that you use the most with an alternate heat source, like a Napoleon Fireplace. Zone Heating is the obvious solution for those families concerned about rising fuel costs.

## Direct Vent Power Venting System

### Freedom and Versatility

Napoleon's new power venting system allows more freedom and versatility for direct vent installations. The option of having the termination above or below the fireplace, along with the ability to "snake" either up or down, allows installation when the desired fireplace location is a great distance away from an outside wall. The blower that pulls the burned gases from the fireplace is mounted outside at the terminal which provides WHISPER QUIET™ operation inside the home.

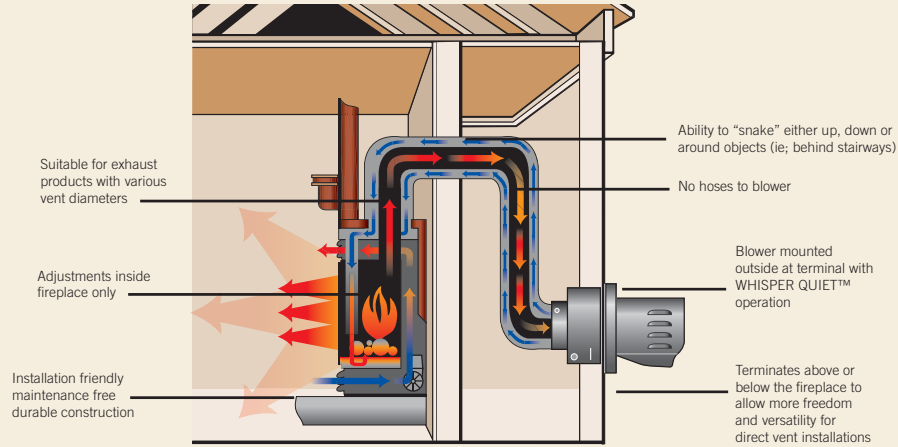

## Heating Flexibility

### Hot Air Distribution Kit

With the hot air distribution kit and its independent fan control, you are offered a choice of distributing a portion of the heat generated from your fireplace to other rooms, adding to your overall home comfort ...

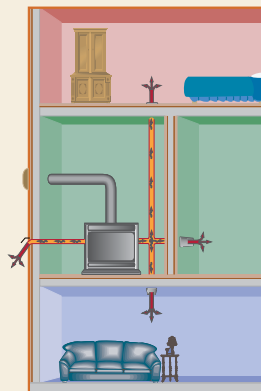

### Thermostat For Hot Air Distribution Kit

Optional thermostatic control maintains adjacent room temperature for even greater convenience.



### Blower

When you want to extract maximum heat, an optional heat circulating blower offers increased heating efficiency throughout the room.

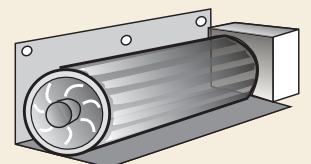

OR

when fireplace heating efficiency is secondary to the ambiance of a fire, disperse it outdoors ... ideal for entertaining.

# Fireplace Features & Accessories

| Prestige Collection  | BGD90 | HD81 | GD80 | GD82-T | GD82 | GD70 |
|--|-------|------|------|--------|------|------|
| Louvres (available in painted black, polished brass finish, brushed stainless steel finish, antique brass finish)          | -     | -    | -    | -      | -    | 0    |
| Ornamental Insets (available in Heritage, Diamond, Gothic, Seashell, Eclipse)**  | -     | -    | -    | -      | -    | 0    |
| Bay Front  | -     | -    | -    | -      | -    | 0    |
| Bay Louvres (available in painted black, polished brass finish, brushed stainless steel finish)                            | -     | -    | -    | -      | -    | 0    |
| Burner Accent Trim (polished chrome)   | -     | 0    | -    | -      | -    | -    |
| 3" Trim (available in polished brass finish, brushed stainless steel finish)   | -     | -    | -    | -      | -    | 0    |
| 3" Bevelled Trim (available in painted black, antique brass finish, polished brass finish, brushed stainless steel finish) | -     | -    | -    | -      | -    | 0    |
| 6" Bevelled Trim (available in painted black, antique brass finish, polished brass finish, brushed stainless steel finish) | -     | -    | -    | -      | -    | 0    |
| Arched Facing Kit  | -     | -    | 0    | 0      | 0    | 0    |
| Arched Facing Kit With Heritage Pattern In Painted Black Finish  | -     | -    | -    | 0      | 0    | -    |
| Arched Facing Kit In Hand Forged Wrought Iron  | -     | -    | 0    | 0      | 0    | -    |
| Rectangular Facing Kit   | -     | -    | 0    | 0      | 0    | -    |
| Faceplate/Door Kit   | 0     | -    | 0    | -      | -    | 0    |
| Stainless Steel Surround and Hearth  | -     | -    | -    | 0      | 0    | -    |
| Safety Screen  | S     | -    | S    | -      | -    | 0    |
| Decorative Door  | 0     | -    | 0    | -      | -    | 0    |
| Cast Iron Surround Kit   | -     | -    | -    | -      | -    | 0    |
| Porcelain Reflective Radiant Panels  | -     | 0    | 0    | -      | 0    | 0    |
| OLD TOWN RED™ Brick Panels   | -     | -    | 0    | -      | -    | 0    |
| Sandstone Herringbone Brick Panels   | 0     | -    | 0    | -      | 0    | 0    |
| Sandstone Decorative Brick Panels  | -     | 0    | 0    | -      | -    | 0    |
| Fluted Refractory Bricks With or Without Napoleon® Insignia  | -     | -    | -    | -      | 0    | -    |
| Country Crane and Hearth Pot   | 0     | -    | -    | -      | -    | -    |
| Traditional Andirons - Available in painted black, 24 Karat gold plated  | S*    | -    | S*   | -      | 0*   | 0    |
| Obelisk Andirons - Available in painted black  | -     | -    | -    | -      | 0    | -    |
| Electronic Ignition  | -     | S    | -    | S      | -    | 0    |
| Hand-held On/Off Remote  | -     | -    | -    | -      | -    | 0    |
| Hand-held Thermostatic Remote - Controls flame, blower and Night Light™  | S     | S    | S    | S      | S    | 0    |
| Night Light™   | S     | S    | S    | S      | S    | S    |

- = Not Available 0= Optional S= Standard \* Painted black only \*\*Painted black available for Heritage insets only. Brushed stainless steel available for Heritage and Diamond insets only. 24 Karat brushed gold plated & brushed copper available on special order only.

Consult your owner's manual for complete and up-to-date installation instructions and proper clearances to combustible materials. Check all local and national building codes and gas regulations. All specifications are subject to change without prior notice due to on-going product improvements. Products may not be exactly as shown. Napoleon is a registered trademark of Wolf Steel Ltd. Patent U.S. 5.307.801, 75054-Can. 2.073.411, 2.082.915, 74589 © Wolf Steel Ltd. Patents Pending.

**EnerGuide** - A Canadian efficiency standard based on frequent, short start-up and cool-down cycles. All appliances sold in Canada are subject to this EnerGuide rating system. **AFUE**- A US efficiency standard (Department of Energy) based on extended on/off cycles, more typical of fireplace usage. **Steady State** - Reflects the highest possible overall heating efficiency.

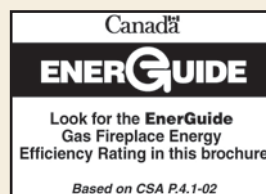

- 103 Miller Drive, Crittenden, Kentucky, USA 41030
- 24 Napoleon Road, Barrie, Ontario, Canada L4M 4Y8
- 7200 Trans Canada Highway, Montreal, Quebec, Canada H4T 1A3

Tel: 705-721-1212 Fax 705-722-6031  
[www.napoleonfireplaces.com](http://www.napoleonfireplaces.com)  
[www.fireplacedesignstudio.com](http://www.fireplacedesignstudio.com)





**QUALITY FIREPLACES**  
*Award Winning Products*

[napoleonfireplaces.com](http://napoleonfireplaces.com)

Printed in Canada ADBR900 12/2008